

Varenummer: 0107047
 Beskrivelse: Seeger låsering AK 30 DIN 983

Mål

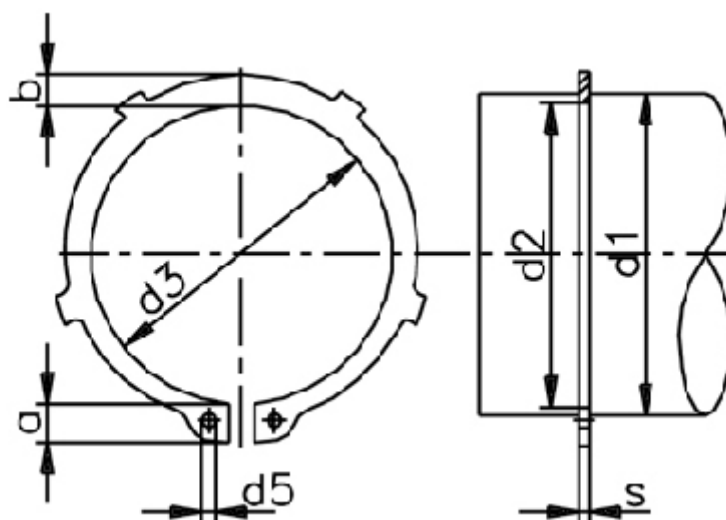

a max	= 4.7	d5 min	= 2.0	Nominal træk	= 2.1
AN mm ²	= 64.4	FN kN	= 10.70	s	= 1.50
Antal takker	= 6	FRg kN	= 7.6	t	= 0.70
b	= 3.4	FR kN	= 32.1	Tang	= ZGA-2
Betegnelse	= AK 30	g	= 1.5	tol	= -0.06
d1	= 30	K kN-mm	= 64.2	tol	= +0,21-0,42
d2	= 28.6	m min	= 1.60	tol	= -0.21
d3	= 27.9	n abl x 1000	= 18	vægt kg/1000	= 3.65